

Thermal insulation with  
Elastopor® H spray foam

Elastogran



■ • BASF Group

## List of contents

	Page
Background information	3
Climate protection and energy savings	4
Overview of applications	5
Key advantages	6
Technical data	7
External wall:	
Internal insulation	8
External insulation and render system	9
External insulation between masonry walls	10
External insulation behind cladding	11
Internal insulation in timber frame wall construction	12
Pitched roof:	
Internal insulation between the rafters	13
External roof insulation over the rafters	14
Insulation on solid pitched roofs	15
Flat roof:	
Insulation on solid flat roofs	16
Insulation on lightweight industrial flat roofs	17
Floor structure:	
Insulation of the loft/attic floor	18
Floor:	
Insulation of floors with underfloor heating	19
Basement ceiling:	
Insulation of basement ceilings/soffit	20
Agricultural buildings:	
Internal insulation of livestock and agricultural buildings	21
Case studies	22
Contact	23





## Leading position in the industry

The Elastogran Group is one of the leading companies in the field of the speciality polyurethanes (PU). This subsidiary of BASF has over 40 years of expertise in polyurethanes and its headquarters in Lemförde, Germany, is the international technology centre for BASF's polyurethanes business. This dynamic market and technology leader in PU specialities, has virtually the full range of polyurethane products in its portfolio.

Elastopor H spray foam systems are approved by the top building inspection authority in Berlin, the "Deutsches Institut für Bautechnik (DIBt)". Other European and non-European countries will have their own separate local approvals.



Its close links with BASF, the world's leading chemical company, means that Elastogran, as part of the worldwide BASF Verbund can tap into global resources for research, supply of raw materials, sales, finance and especially environmental protection.

## This is Elastopor® H

Elastopor® H spray foam is a closed-cell, rigid polyurethane foam. This is produced by an exothermic reaction between a polyol component and an isocyanate. At the end of the reaction phase, the foam begins to solidify and cure. Applied with a spray gun in several layers, Elastopor H provides seamless thermal protection. The field of application covers virtually all areas of flat and pitched roofs, ceilings, walls and floors.



## Cooperation and convenience for the customer

In the European Economic Community, Elastogran runs BASF's PU business through a series of local system houses which can offer a rapid response to developing individual solutions via technical service, sales and marketing. BASF's leading position in the market of manufacturing polyurethane basic products is underpinned by large-scale plants in all regions of the world.

Working on the principle "We help our customers become more successful", Elastogran develops individual, customised solutions and also creates its own innovative product applications. Elastogran has initiated numerous projects in partnership with its customers, both in the form of new products and also with specific developments in new fields of application.



## Climate protection and energy savings

Climate change is one of the major industrial challenges of our time. Business, science, politics and industry are being called upon to slow down any further rise in greenhouse gas emissions and use available resources more efficiently.

It is clear to everyone today that there is a finite limit to fossil fuel sources. Natural gas has recently become a focus of speculation.

Faced with these facts, various concepts and strategies for sustainable protection of the environment and climate, for the future, have been put forward. A key approach is improving thermal insulation in buildings.

A concern for property owners is energy conservation measures and the costs entailed. The technologies and materials required, have been available for some time and can be very cost effective. In many cases, investing in thermal insulation measures pays for itself in less than ten years, and in many countries grants and attractive loans are being given. Get on board!

## Thermal insulation of buildings

New and old buildings are today and will be in the future very largely subject to energy saving and environmental protection requirements. The focus here is on thermal insulation and sealing of buildings and roofs.

From a structural point of view, roofs are the most exposed parts of a building. They have to withstand heat and cold, wet and dry conditions, storms and snow, and even decades later still be water-tight and provide reliable thermal insulation. Elastopor H represents up-to-date, environmentally- and energy-aware and economic insulation.

## Energy certification of buildings

The Kyoto Protocol has put pressure on the industrialised countries to reduce emissions of greenhouse gases. According to the EU directive, energy certification aims to create incentives to carry out renovation measures. It gives information on the energy rating of buildings and is intended to be given to potential buyers or people renting property for construction, purchase or rental purposes.

Country example:

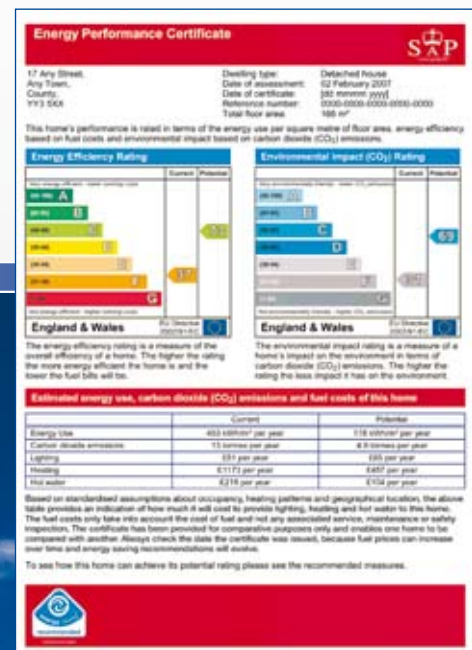



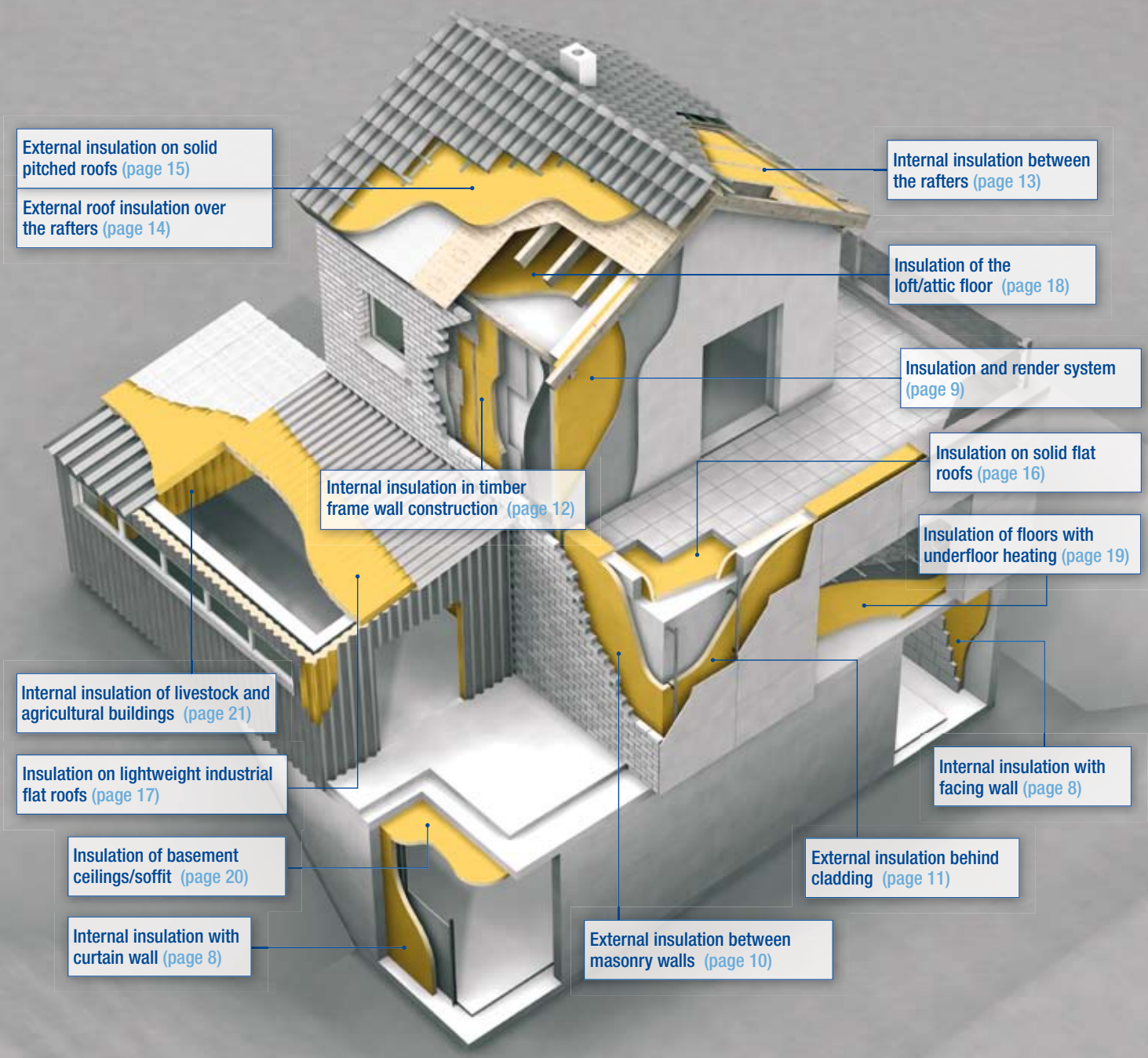

## Versatile insulation with Elastopor H

Elastopor H systems are produced directly on the substrate to be insulated using a pouring or spray process. The material forms a continuous, even insulating layer with no joints or gaps, eliminating any thermal bridges. Spray foam is the ideal solution for a very wide variety of surfaces and shapes because the material adapts to any profile without gaps.

The versatile options for using Elastopor H, range from insulating flat roofs in new buildings through flat and sloping roof renovation in old buildings and commercial premises. The range of application is not just restricted to the external insulation of roofs. Its application properties also make Elastopor H suitable for installation on the underside of roofs. The same applies for internal, external and cavity insulation of external walls, basement ceiling and soffit insulation.

The installation method of the system is the same for internal areas as for external insulation. A comparison with conventionally insulated roofs and walls, clearly shows that Elastopor H is more cost-effective to produce and with the same layer thickness, has a much better thermal conductance than other insulating materials.

The closed cell structure means that Elastopor H is water-resistant and at the same time provides a seal against the effects of weathering and temperature. A UV protective membrane is applied as an external coating for flat or pitched roofs.

## Key advantages

## at a glance

Insulation with no joints or gaps

▶ Spray application of Elastopor H insulating material produces a seamless insulating layer with no joints or gaps and reduces energy loss due to thermal bridging.

Maximum insulating performance at minimum thickness

▶ Elastopor H has an extremely low thermal conductivity not achieved by any other conventional insulating material, saving valuable space.

Insulation of components in hard to treat areas

▶ “Liquid” installation means that critical, inaccessible or curved areas can be insulated without any problem – no need for laborious cutting and fitting.

Excellent adhesion to the substrate

▶ Elastopor H fits like a second skin and is suitable for virtually all substrates such as corrugated fibre cement, profiled metal sheet or timber boards.

Prolongs the life of buildings

▶ Elastopor H rigid, robust, closed-cell foam demonstrably improves the construction and life of buildings.

Rapid installation times

▶ An experienced installation team can treat many m<sup>2</sup> of roof area a day with a foaming unit, when conditions are favourable.

Safe, professional installation

▶ Trained, qualified people from certified installation companies guarantee safe, accurate application of the spray foam.

Increases comfort in the home

▶ Residents of buildings insulated with Elastopor H report an improved indoor environment and a greater degree of comfort.

Low material weight

▶ Elastopor H's low weight places very little stress on components, making it safer for example when there is heavy snow on flat roofs.

Quality assurance through self-monitoring

▶ Elastogran is certified to BS EN ISO 9001, ISO/TS 16949:2002 and BS EN ISO 14001. Each batch is checked and tested before delivery. The relevant countries have local product certifications for Elastopor H.

Easy to transport and store

▶ Elastopor H is foamed as a liquid mixture on site which means rapid transport and space-saving storage at the site.

## Economic insulation

## ▶ Elastopor H



## General technical information

Elastopor H's excellent technical physical properties mean it is very versatile.

With a maximum aged thermal conductivity ( $\lambda$ ) of 0.028 W/(m·K), thin insulating layers can be produced with Elastopor H.

Elastopor H is frost- and heat-resistant from -50°C to +100°C.

Elastopor H is resistant to heavy acids and alkalis, seawater, industrial waste gases and aliphatic hydrocarbons (mineral oil, petrol, diesel fuel, etc).

Further technical information, approvals, data sheets and specifications are available on request from Elastogran.



## Key physical and technical features

Properties Application	Low foam density Wall / roof	High foam density Floor / patio / roof capable of withstanding foot traffic	Unit	Standard
Density	33 - 45	45 - 60	kg/m <sup>3</sup>	EN 1602
Long-term water absorption	< 2	< 2	%	EN 12087
Closed cell structure	> 90	> 90	%	ISO 4590
Fire performance construction material class *	E	E		EN 13501-1
Thermal conductivity $\lambda$ (calculated value)	0,028	0,028	W/(m·K)	EN 12667
Impermeability to water (at 0.6 bar)	waterproof	waterproof		EN 1928
Compressive strength (10% compression)	0,15 - 0,20	0,20 - 0,40	N/mm <sup>2</sup>	EN 826

\* E = standard value; systems in the range with a high level of fire protection.



# External wall

## Internal insulation with Elastopor H

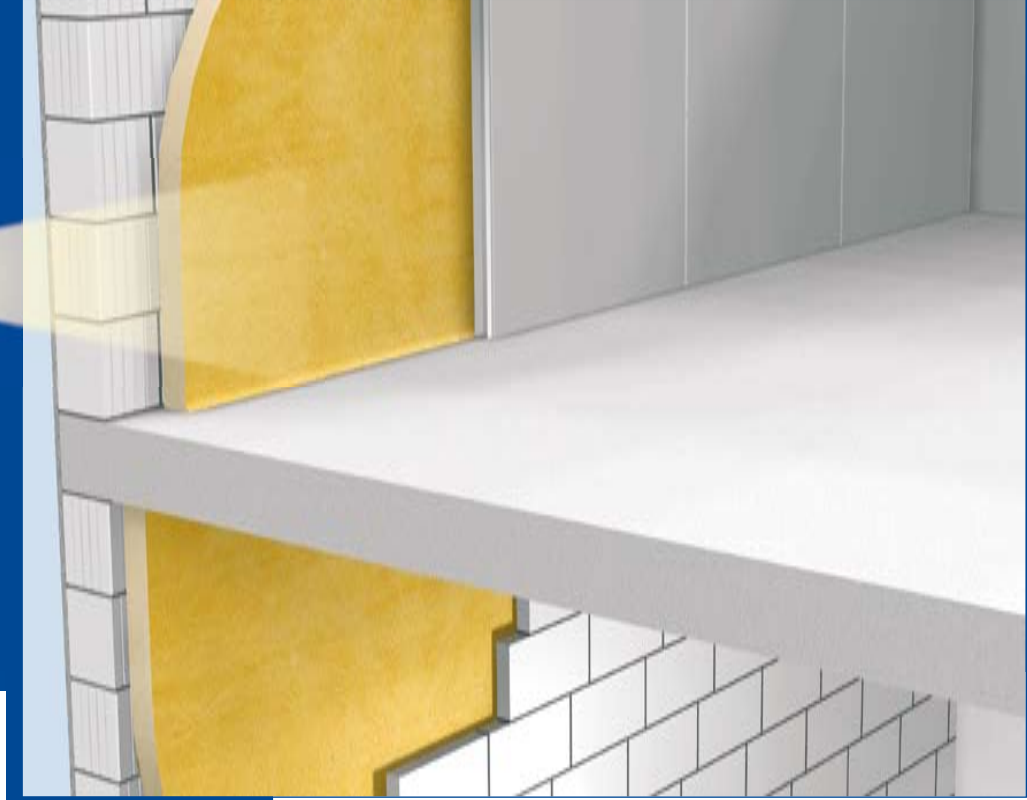

Insulation on the inside of external walls is the best solution if insulation from outside is not an option. Even older buildings with listed facades or those worth preserving often have low thermal insulation which can be improved by more than 60% by internal insulation. Installation is also comparatively cost-effective because no scaffolding is required for the building and it can be applied on a room by room basis. Since the internal surface temperature of the wall is increased by approx. 2 to 4 degrees, this has a positive effect on the indoor climate.

Elastopor H insulating material is easy to apply to the inside of the external wall using the spray foam process. After a short curing time, the insulating layer is cladded on the room side using plasterboard or timber boards, decorative exposed brickwork or plastered brickwork. Comparatively little living space is lost due to the excellent insulating performance of even a thin layer of Elastopor H.

- ▶ flexible internal wall design
- ▶ rooms heat up rapidly
- ▶ vapour barrier not absolutely necessary
- ▶ comparatively little loss of space

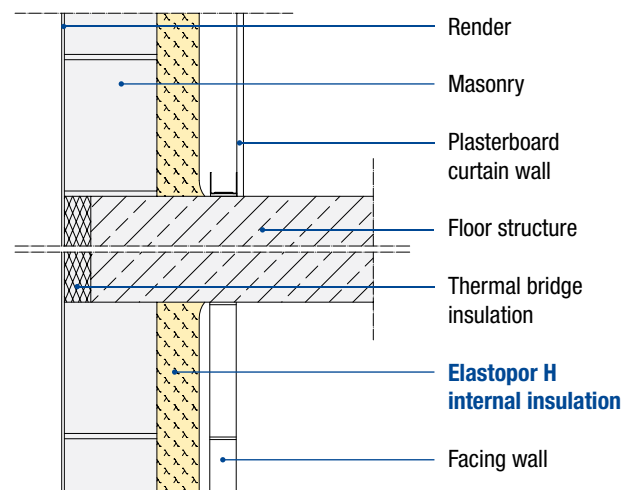

External wall with internal insulation and a lightweight or solid facing wall

The installation of a vapour barrier must be checked in line with structural, climatic or regional conditions and building regulations.

Wall structure	Thermal conductance U-value W/(m <sup>2</sup> ·K) with Elastopor H *						
	without insulation	40 mm	60 mm	80 mm	100 mm	120 mm	140 mm
Perforated brick 240 mm, thermal conductivity $\lambda = 0.50$ W/(m·K)							
Internal plasterboard curtain wall	1,41	0,47	0,35	0,28	0,23	0,20	0,18
Internal facing wall 60 mm	1,26	0,45	0,34	0,27	0,23	0,20	0,17

\* Thermal conductivity Elastopor H,  $\lambda = 0.028$  W/(m·K)



# External wall

## External insulation and render system with Elastopor H

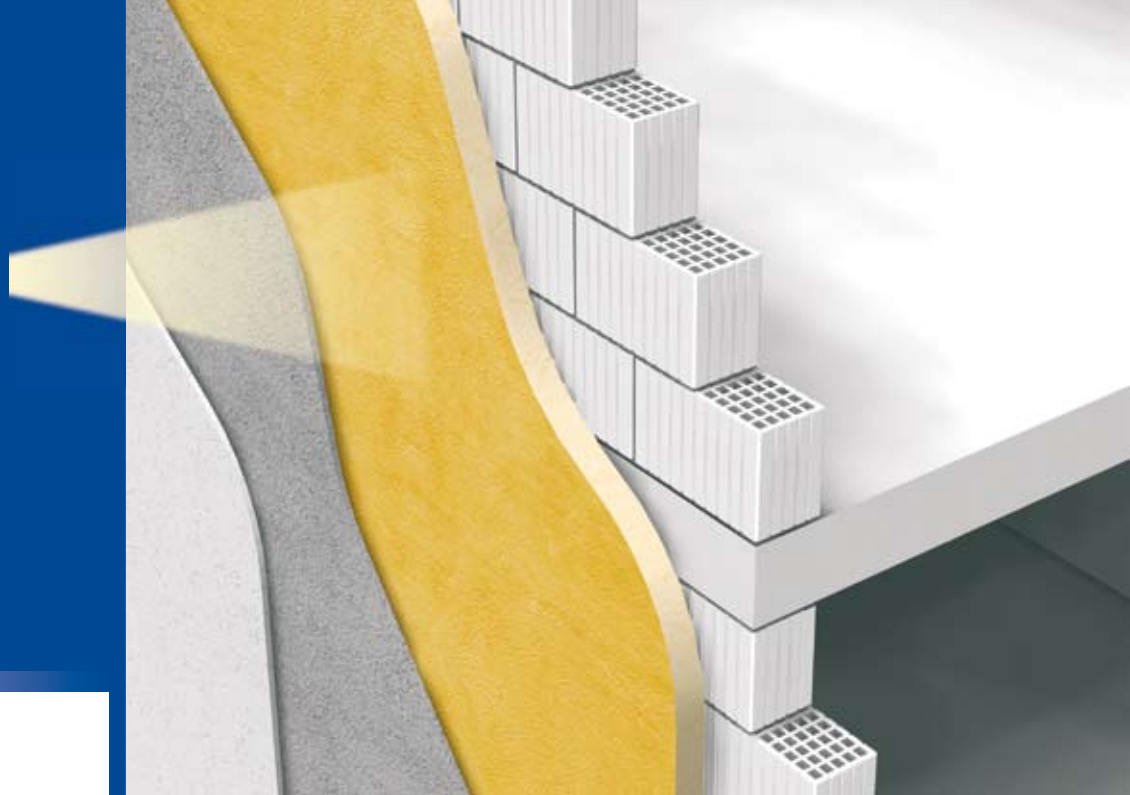

External walls are normally the largest external surface area of buildings through which heat can escape virtually unchecked. Between 100 and 150 kilowatt hours of heating energy are lost through one square meter of uninsulated wall per year, corresponding to approximately 10 to 15 litres of heating oil or 10 to 15 cubic metres of gas. This can be reduced by up to 90% with Elastopor H external thermal insulation.

Elastopor H high thermal insulation spray foam is applied directly to the dust-free wall at specific points without a primer. A special primer plaster is applied directly to the cured insulating layer as an adhesion promoter for the final decorative skim. Dowelling of the insulation or incorporation of a fabric layer required with conventional systems is not required.

- ▶ time- and cost-saving installation
- ▶ reinforces the wall construction
- ▶ insulating layer with no thermal bridge
- ▶ individual design with decorative plaster

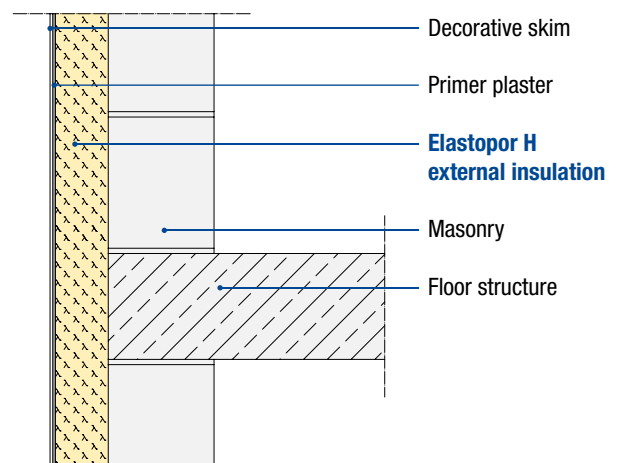

Masonry with external insulation and skim

Wall structure	Thermal conductance U-value W/(m <sup>2</sup> ·K) with Elastopor H *						
	without insulation	40 mm	60 mm	80 mm	100 mm	120 mm	140 mm
Perforated brick 240 mm, thermal conductivity $\lambda = 0.50$ W/(m·K)	1,54	0,48	0,36	0,29	0,24	0,20	0,18
The internal plaster is not considered thermal insulation.							

\* Thermal conductivity Elastopor H,  $\lambda = 0.028$  W/(m·K)

# External wall

## External insulation between masonry walls with Elastopor H

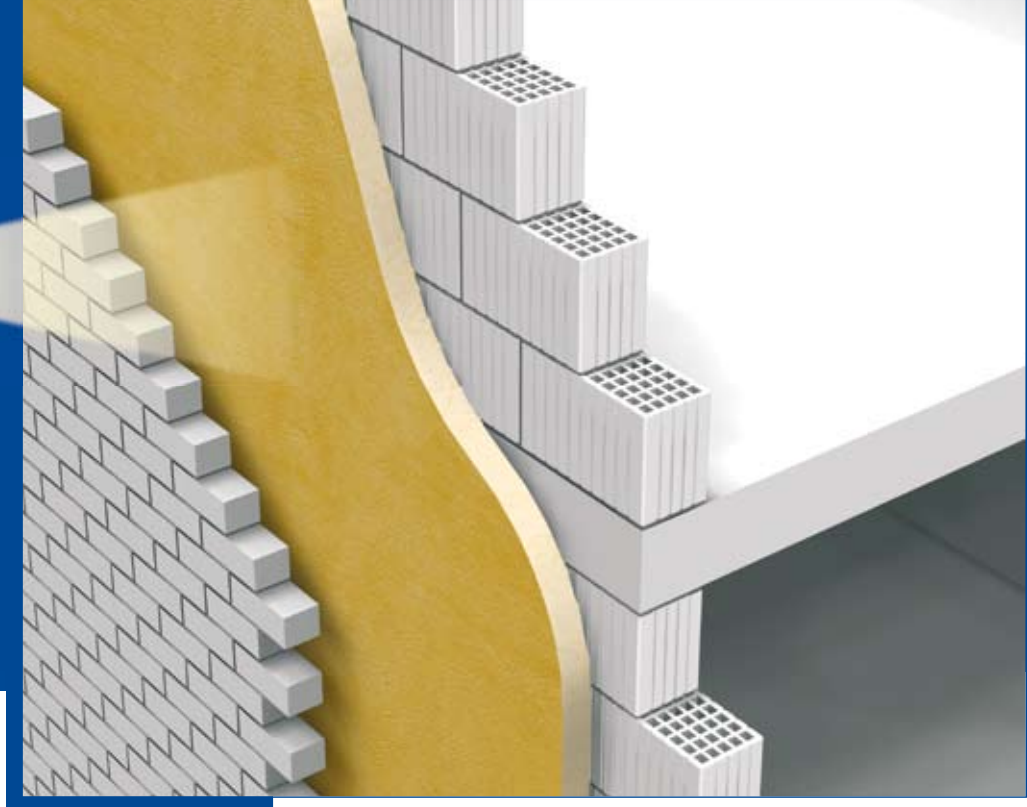

Many buildings are designed with double skin masonry for visual or structural reasons or as protection against extreme weather conditions. The cavity is given an insulating layer so that the cold air between the facing wall and the lining wall does not then cool the external wall and therefore have a negative effect on the energy consumption of the building.

The PU foam is applied to the external wall in layers with no joints. The substrate must be dry and dust-free for the insulation material to adhere securely. The facing wall made of for example clinker bricks, quarry stone or plastered masonry forms the outer exposed cladding and at the same time serves as a protective layer. Normally there is a 3 to 4 cm air gap between the insulation and the facing which dries off any penetrating moisture or rainwater. Elastopor H pouring system can also be injected through small holes drilled in the masonry. This fully fills the cavity, bonding the two leaves together. This can be used to overcome any structural problems in combination with the best cavity wall insulation on the market, thickness for thickness.

- ▶ safe protection of the fabric of the building
- ▶ individual design of the facade
- ▶ weather-resistant and rot-proof
- ▶ moisture-resistant

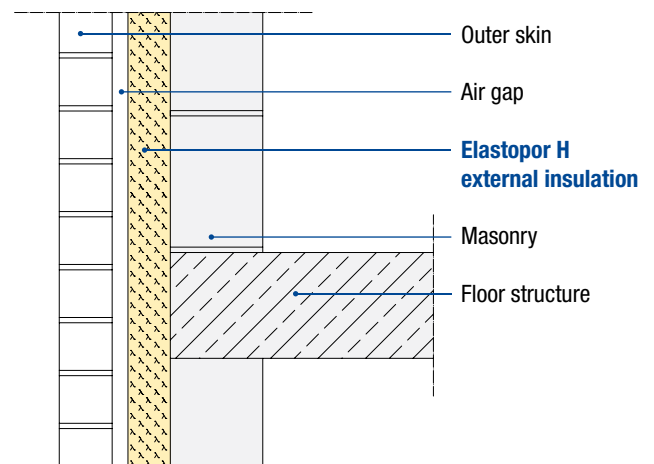

Double skin masonry with core insulation and air gap

Wall structure	Thermal conductance U-value W/(m <sup>2</sup> ·K) with Elastopor H *						
	without insulation	40 mm	60 mm	80 mm	100 mm	120 mm	140 mm
Perforated brick 240 mm, thermal conductivity $\lambda = 0.50$ W/(m·K) Outer skin and air gap	1,28	0,45	0,34	0,28	0,23	0,20	0,17
The internal plaster is not considered thermal insulation.							

\* Thermal conductivity Elastopor H,  $\lambda = 0.028$  W/(m·K)

# External wall

External insulation behind cladding, using Elastopor H

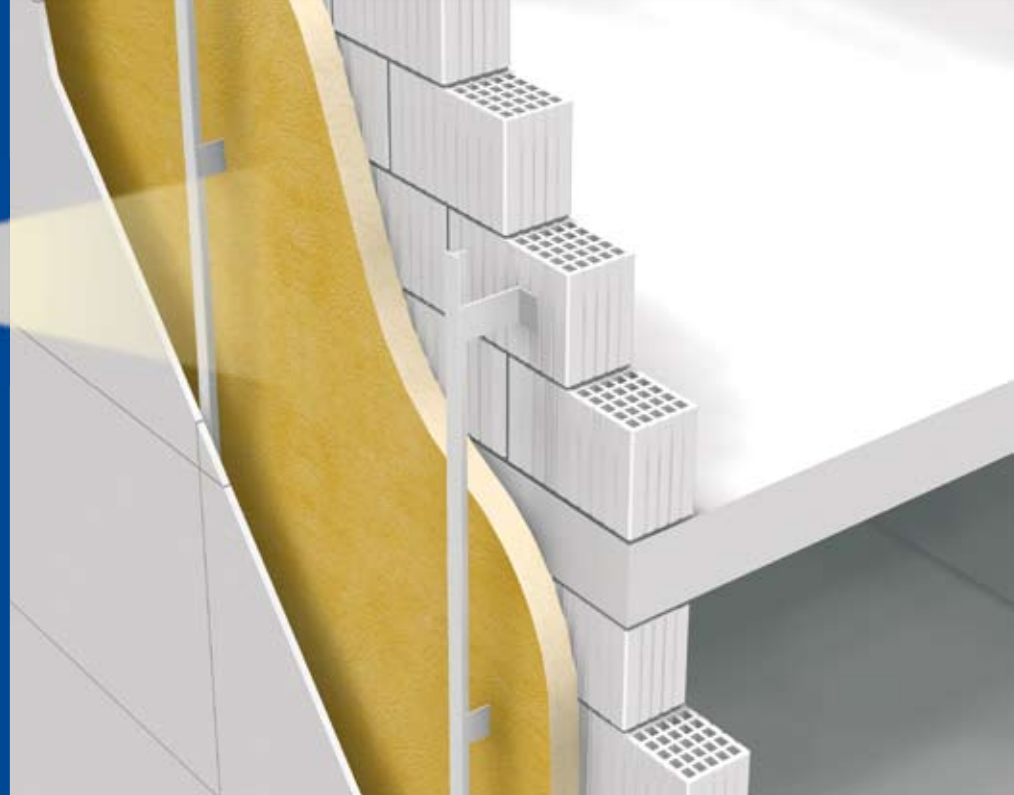

The external insulation behind a curtain wall or with ventilated cladding can be used both in new buildings and refurbishment of existing buildings. The cladding protects the external components against weathering and as a decorative facade gives a designer, lots of options

Metal supports for the cladding are prefixed to the wall then Elastopor H is sprayed onto the wall and around these fixings. Depending on the type of cladding, a system of vertical timber laths or aluminium support rails are then installed to attach the curtain wall. There should be a 2 to 4 cm ventilation gap between the curtain wall and the insulation to dry off any moisture that occurs in this area.

- ▶ good weather protection for the external wall
- ▶ versatile facade design
- ▶ increases comfort in the house
- ▶ no problems with moisture

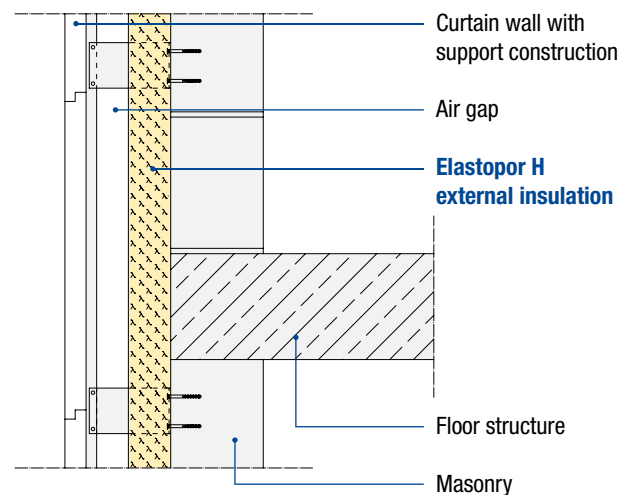

External wall with thermal insulation and curtain ventilated cladding

Wall structure	Thermal conductance U-value W/(m <sup>2</sup> ·K) with Elastopor H *						
	without insulation	40 mm	60 mm	80 mm	100 mm	120 mm	140 mm
Perforated brick 240 mm, thermal conductivity $\lambda = 0.50$ W/(m·K) Curtain wall and air gap	1,51	0,48	0,36	0,28	0,24	0,20	0,18
The internal plaster is not considered thermal insulation.							

\* Thermal conductivity Elastopor H,  $\lambda = 0.028$  W/(m·K)



# External wall

## Internal insulation in timber frame wall construction using Elastopor H

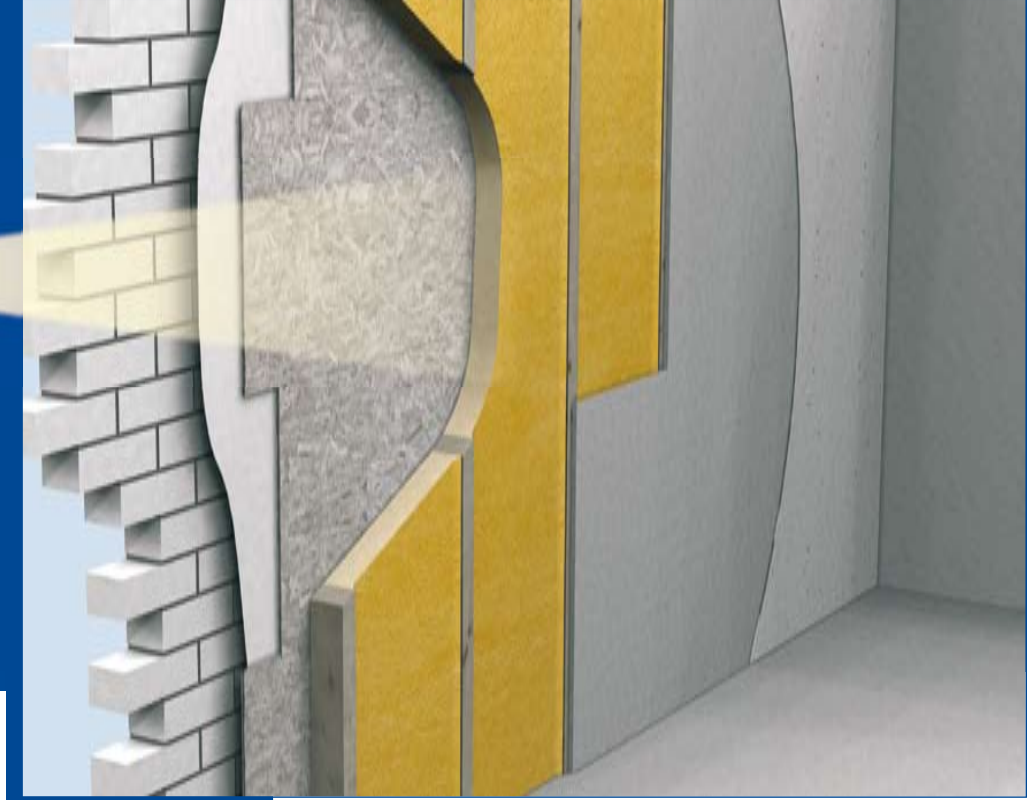

Timber frame construction is typical in Great Britain, USA and Canada. As the name suggests, this method of construction relies on a timber frame as a basic means of structural support. The outer leaf is typically stone, brick, render or timber, to suit the local district or planning requirements.

Elastopor H is applied between the studwork of the timber frame for thermal insulation. The low thermal conductivity of the material has clear advantages here because despite low wall thicknesses, a comparatively high insulating performance is achieved. The cured spray foam guarantees additional support and stability for the whole of the timber frame construction. The “in-situ” application of the foam also guarantees air tightness of the structure, something traditional insulation methods cannot do. There must be an air gap between the external facing and the insulated timber frame for ventilation.

- ▶ space-saving wall construction
- ▶ rapid assembly and insulation
- ▶ individual facade design
- ▶ guaranteed air barrier

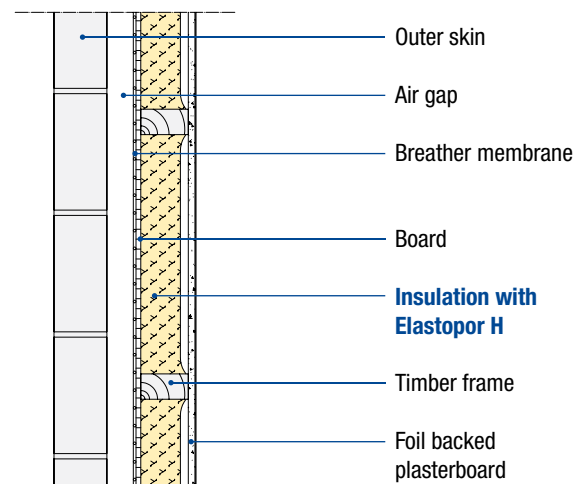

Timber frame construction with thermal insulation between studwork and ventilated outer skin (horizontal section)

Wall structure	Thermal conductance U-value W/(m <sup>2</sup> ·K) with Elastopor H *						
	60 mm	70 mm	80 mm	90 mm	100 mm	120 mm	140 mm
Plasterboard cladding Timber studs 60 / 100 or bigger, spacing e = 62.5 cm, timber 9.6% timber formwork Outer skin with air gap	0,43	0,38	0,35	0,32	0,30	0,26	0,23

\* Thermal conductivity Elastopor H,  $\lambda = 0.028 \text{ W/(m·K)}$

# Pitched roof

## Internal insulation between the rafters with Elastopor H



In times of rising energy costs and shortage of living area, loft conversions are becoming increasingly popular. Elastopor H can be applied from inside the loft space without the need for re-roofing, adding another room to the house, cost effectively.

Since the rafters of existing homes are normally only 10 to 14 cm thick, the thickness of insulation with conventional material between the rafters is often not enough to meet today's thermal insulation requirements. Elastopor H's extremely low thermal conductivity and high insulating performance with a low thickness, means there is no need to extend the depth of rafters which is costly in terms of both time and money. Using the proven Elastogran spray foam process, Elastopor H is simply sprayed between the timber rafters without the need for laborious cutting and fitting. This produces a solid, air tight foam layer, with a high thermal insulation effect without energy wasting joints that occur when normal insulation materials are laid.

- ▶ delete ADD – prevents air leakage
- ▶ seamless insulation reducing thermal bridges
- ▶ no laborious cutting and fitting of the insulating material
- ▶ rapid installation not dependant on weather conditions

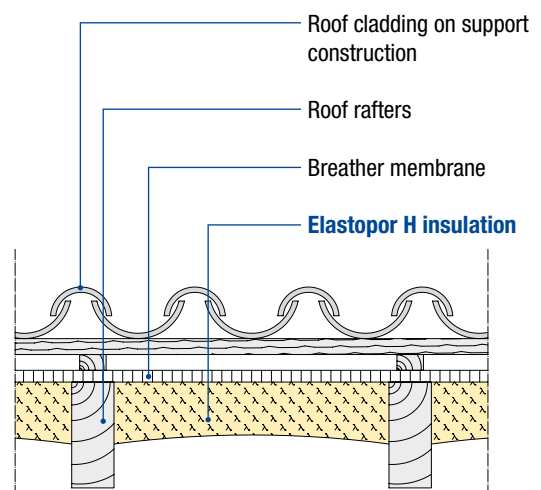

Rafter roof with membrane and internal between-rafter insulation

The installation of a vapour barrier must be checked in line with structural, climatic or regional conditions and building regulations.

Roof construction	Thermal conductance U-value W/(m <sup>2</sup> -K) with Elastopor H *							
	40 mm	60 mm	80 mm	100 mm	120 mm	140 mm	160 mm	180 mm
Between-rafter insulation								
Roof rafters 8 / 16 Spacing e = 70 cm, timber content 11.4% Top roof skin 19 mm	0,61	0,46	0,37	0,31	0,27	0,24	0,22	0,20
The air gap and roof construction above the roof skin are not considered thermal insulation.								

\* Thermal conductivity Elastopor H,  $\lambda = 0.028 \text{ W/(m}\cdot\text{K)}$

# Pitched roof

## External roof insulation over the rafters using Elastopor H

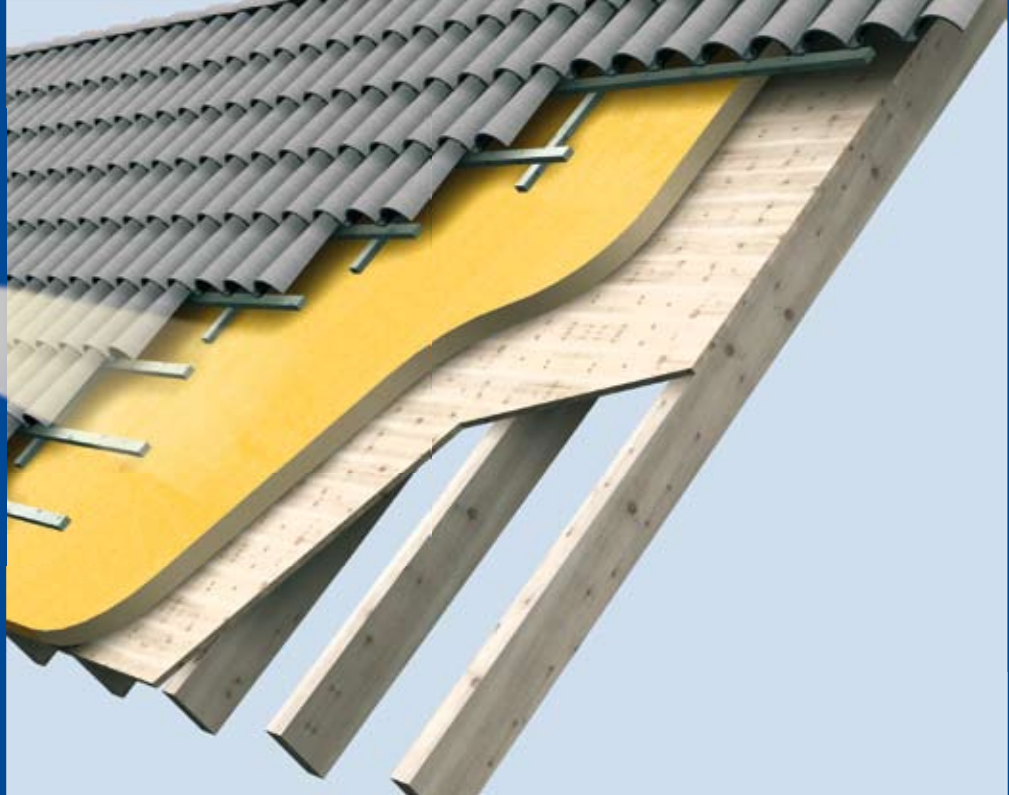

“Over-rafter” insulation means thermal insulation above the rafters. The insulating material is applied to the roof rafters from outside and only then is the roof covered – the rafters and roof board can still be visible from inside the room. Over-rafter insulation is an advantage if energy conservation and re-roofing are required. Ideal for attic rooms and loft conversions

As with solid roof insulation, Elastopor H insulating material is applied directly to the board attached to the roof rafters. Since the external insulating layer is exposed to extreme variations in temperatures, the dimensional and volume stability of Elastopor H helps prevent any cracks or deformations occurring.

- ▶ jointless, full cover thermal insulation
- ▶ thermal bridge-free insulation
- ▶ no disturbance during installation
- ▶ high insulating performance due to variable thickness of insulating material

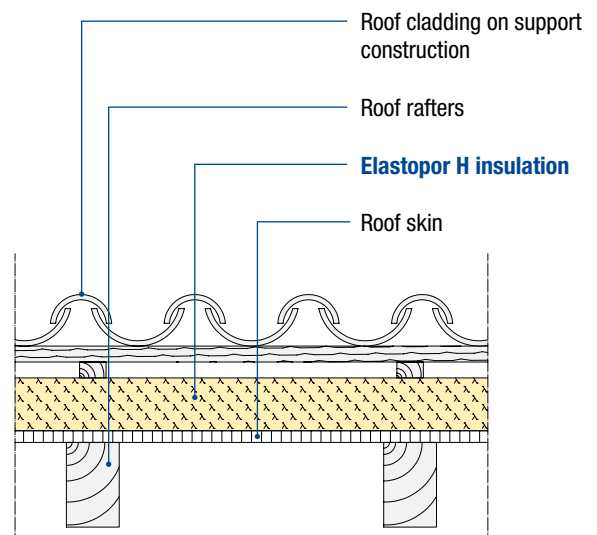

Rafter roof with visible rafters, top roof skin and external thermal insulation

The installation of a vapour barrier must be checked in line with structural, climatic or regional conditions and building regulations.

Roof construction	Thermal conductance U-value W/(m <sup>2</sup> ·K) with Elastopor H *							
	40 mm	60 mm	80 mm	100 mm	120 mm	140 mm	160 mm	180 mm
Roof rafters 8 / 16 top roof skin 21 mm	0,58	0,41	0,32	0,26	0,22	0,19	0,17	0,13
The air gap and roof structure above the thermal insulation layer are not considered thermal insulation.								

\* Thermal conductivity Elastopor H,  $\lambda = 0.028 \text{ W/(m·K)}$



# Pitched roof

## Insulation on solid pitched roofs using Elastopor H

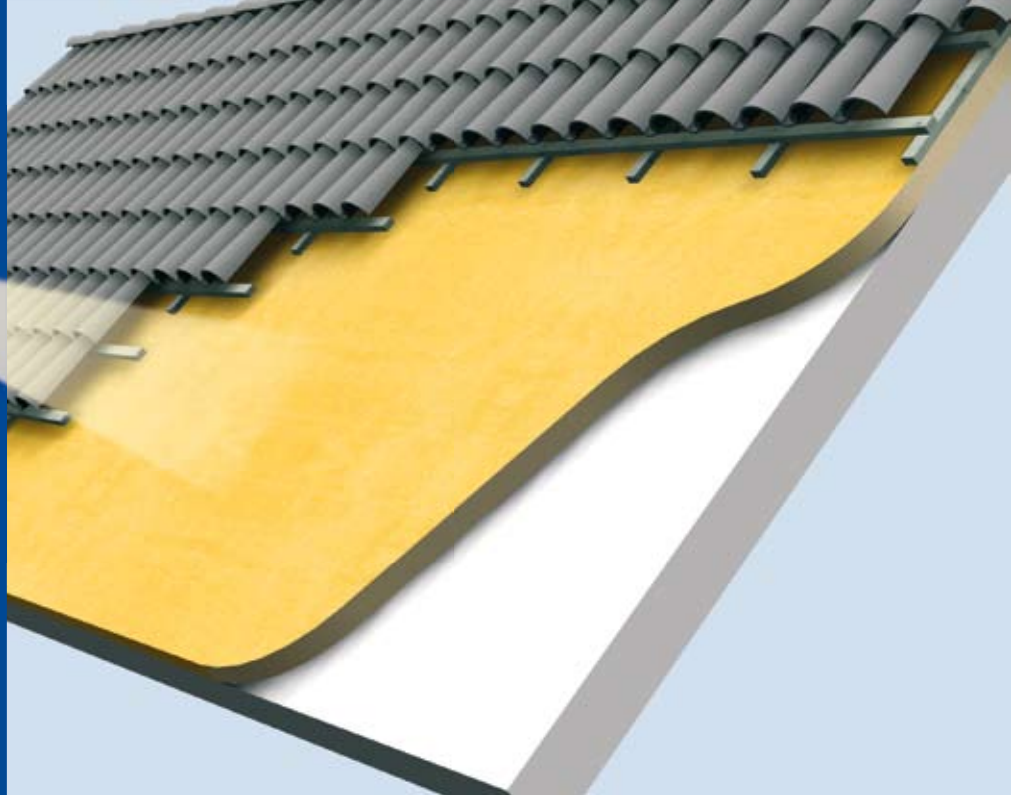

Solid roofs are basically composed of sloping external walls with all the associated structural properties. The roof is quickly assembled from prefabricated units on site by the manufacturer and virtually any shape of roof is possible. Since solid roofs normally consist of concrete, they have primarily fire and acoustic insulation benefits. They provide an effective screen for street and aircraft noise and ensure maximum fire resistance. Other aspects are a high level of safety in the event of storms and thermal insulation in summer. This provides a pleasant living environment under the roof as a result of the external insulation of the rooms.

Elastogran's Elastopor H spray foam is spray-applied simply, quickly and straightforwardly to the dry, dust-free surface of the roof. No vapour barrier between the solid roof and the insulating layer is required.

- ▶ pleasant indoor climate
- ▶ thermal insulation in summer
- ▶ improved noise and fire protection
- ▶ thermal bridge-free roof construction

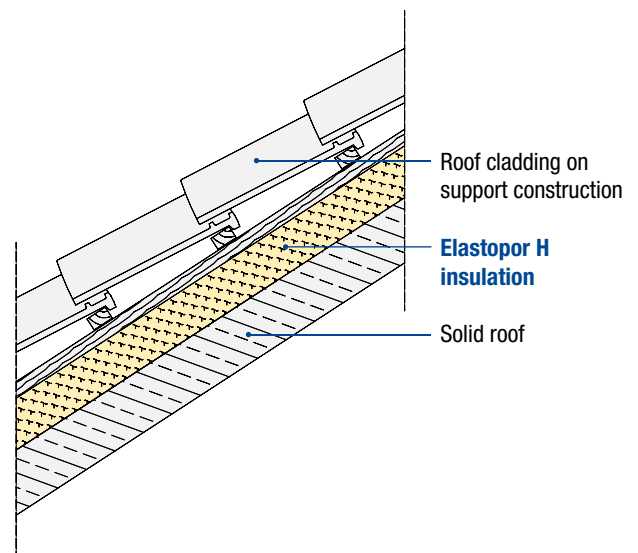

Solid pitched roof with external thermal insulation

The installation of a vapour barrier must be checked in line with structural, climatic or regional conditions and building regulations.

Roof construction	Thermal conductance U-value W/(m <sup>2</sup> ·K) with Elastopor H *							
	40 mm	60 mm	80 mm	100 mm	120 mm	140 mm	160 mm	200 mm
Solid roof / reinforced concrete 160 mm, Thermal conductivity $\lambda = 2.10 \text{ W/(m}\cdot\text{K)}$	0,61	0,42	0,33	0,26	0,22	0,19	0,17	0,14
The air gap and roof structure above the thermal insulation layer are not considered thermal insulation.								

\* Thermal conductivity Elastopor H,  $\lambda = 0.028 \text{ W/(m}\cdot\text{K)}$

# Flat roof

## Insulation on solid flat roofs using Elastopor H

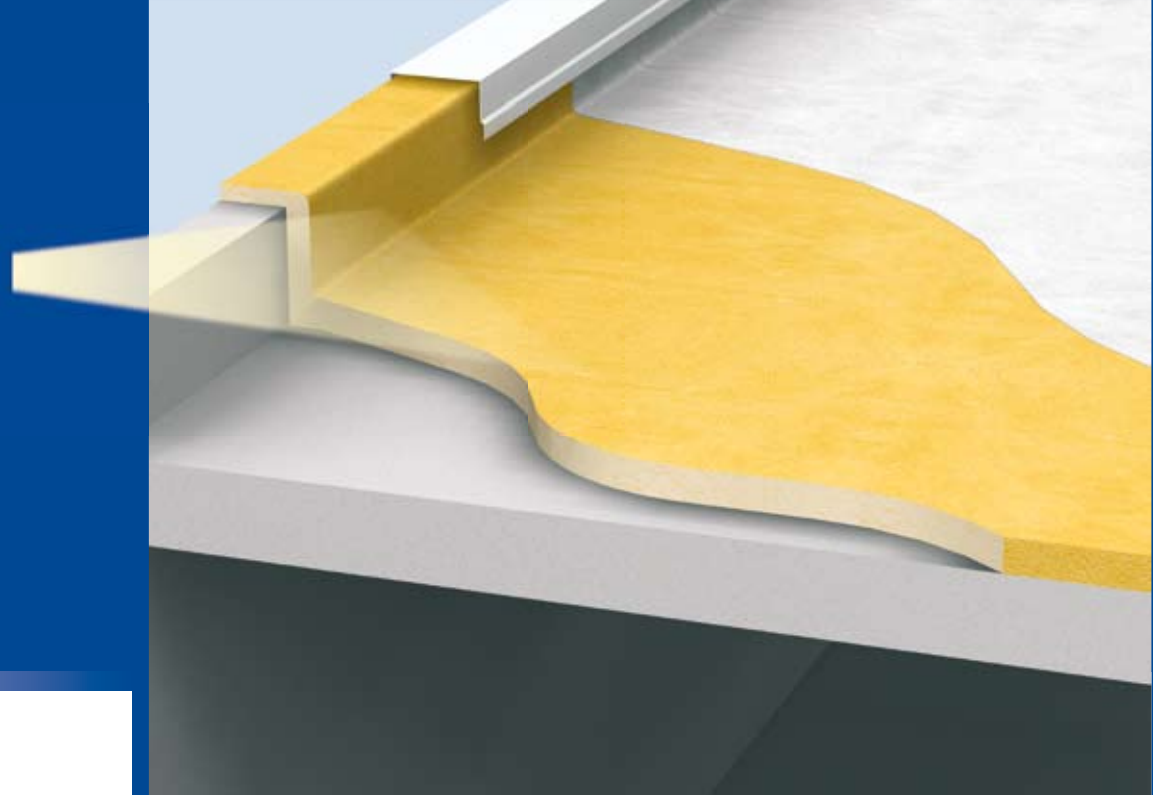

Flat roof coatings in new and existing buildings, is one of the main areas of application for Elastopor H PU spray foam. Insulating flat roofs places high demands on the insulating material because roof areas have to withstand very different conditions such as extreme variations in temperature and exposure to snow, wind and rain.

Coating the roof with Elastopor H has been proved to produce up to 80% savings in time and up to 50% in investment costs compared with conventional insulating methods. Particularly critical areas and those difficult to access on domed areas or parapets can be easily insulated. Even existing old bitumen-treated felt roofing can be easily sprayed over. The insulating foam cures very quickly and can be walked on after a few minutes. A UV protective layer from a range of recommended membrane coating products is then applied.

- ▶ simple, seamless insulation of critical areas
- ▶ suitable for virtually all substrates
- ▶ economic due to rapid treatment
- ▶ durable and rot-proof

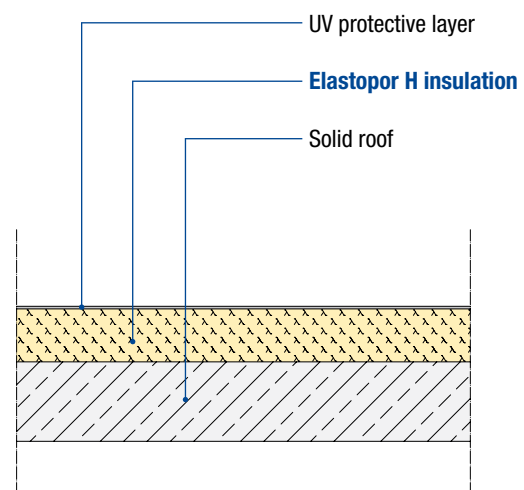

flat roof with external thermal insulation and UV protective layer

The installation of a vapour barrier must be checked in line with structural, climatic or regional conditions and building regulations.

Roof construction	Thermal conductance U-value W/(m <sup>2</sup> ·K) with Elastopor H *							
	without insulation	40 mm	60 mm	80 mm	100 mm	120 mm	160 mm	200 mm
Solid ceiling / reinforced concrete 160 mm, Thermal conductivity $\lambda = 2.10 \text{ W/(m}\cdot\text{K)}$	4,49	0,61	0,42	0,33	0,26	0,22	0,17	0,14
The internal plaster is not considered thermal insulation.								

\* Thermal conductivity Elastopor H,  $\lambda = 0.028 \text{ W/(m}\cdot\text{K)}$

# Flat roof

## Insulation of lightweight industrial flat roofs using Elastopor H

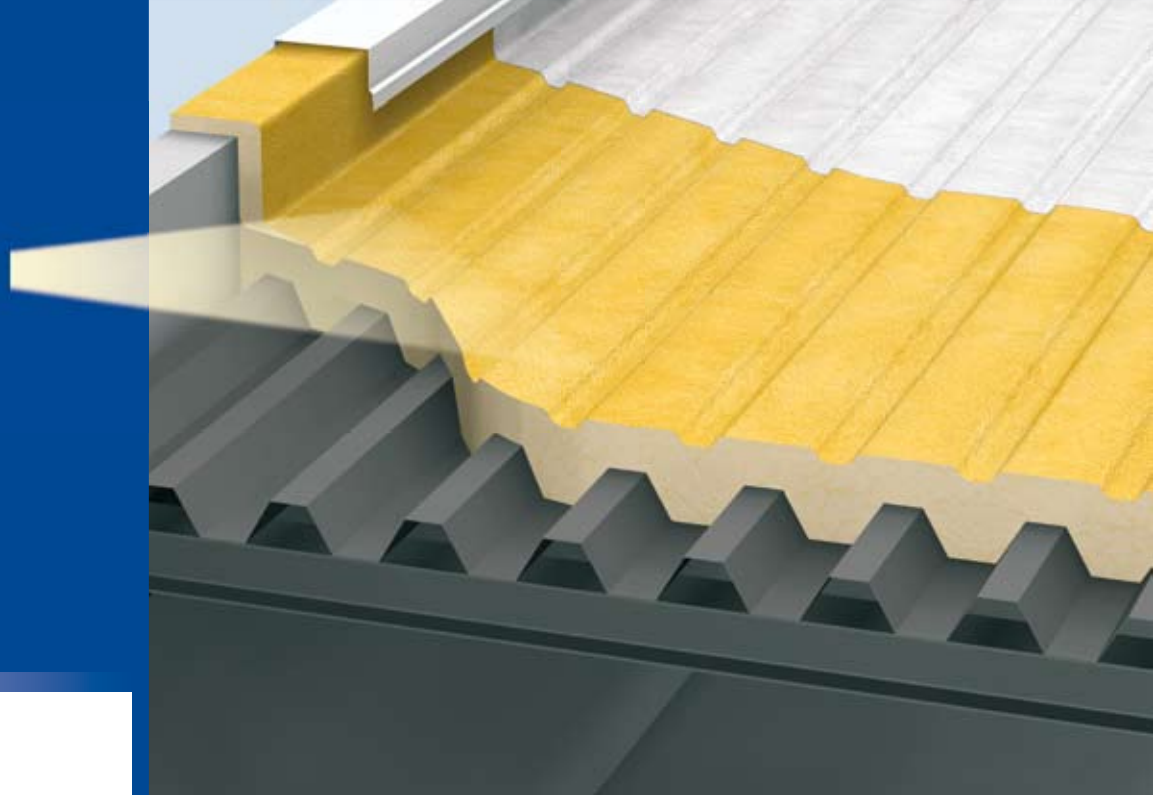

As with the insulation of solid flat roofs, thermal insulation of industrial roofs is one of the traditional applications of Elastopor H. Roofs of warehouses, production facilities, exhibition and sports halls are normally made of profiled metal sheet and have relatively large spans. These lightweight roof constructions require a lightweight insulating material to be able to take the additional loads produced by snow, wind and rain.

Because of its in-situ installation properties, Elastopor H can be applied to the metal sheet profile seamlessly, coating both the peaks and troughs in the profile. The insulating layer then only needs to be provided with UV protection. Vapour barriers, sloping screeds or other additional materials are not normally needed, saving valuable time and money.

- ▶ low weight of the insulating foam
- ▶ adapts to any profile without gaps
- ▶ large areas can be treated in just one day
- ▶ high compressive strength, dimensionally stable

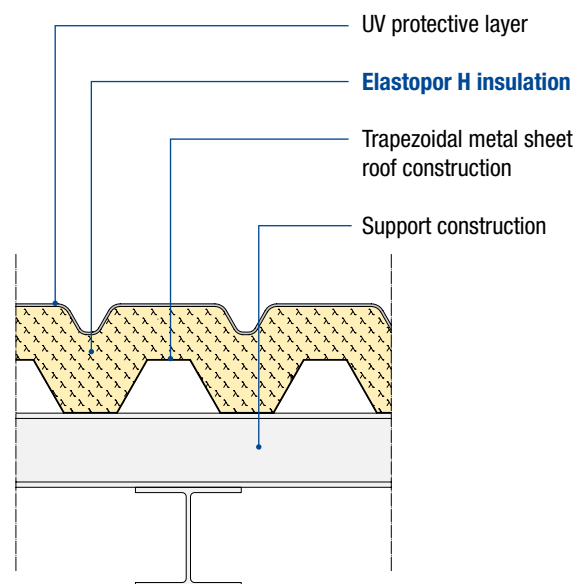

Trapezoidal metal sheet roof with external insulation and UV protective layer

Roof construction	Thermal conductance U-value W/(m <sup>2</sup> ·K) with Elastopor H *						
	without insulation	40 mm	60 mm	80 mm	100 mm	120 mm	140 mm
Trapezoidal metal sheet	6,83	0,64	0,44	0,33	0,27	0,23	0,19

\* Thermal conductivity Elastopor H,  $\lambda = 0.028 \text{ W/(m·K)}$



# Floor structure

## Insulation of the loft/attic floor using Elastopor H

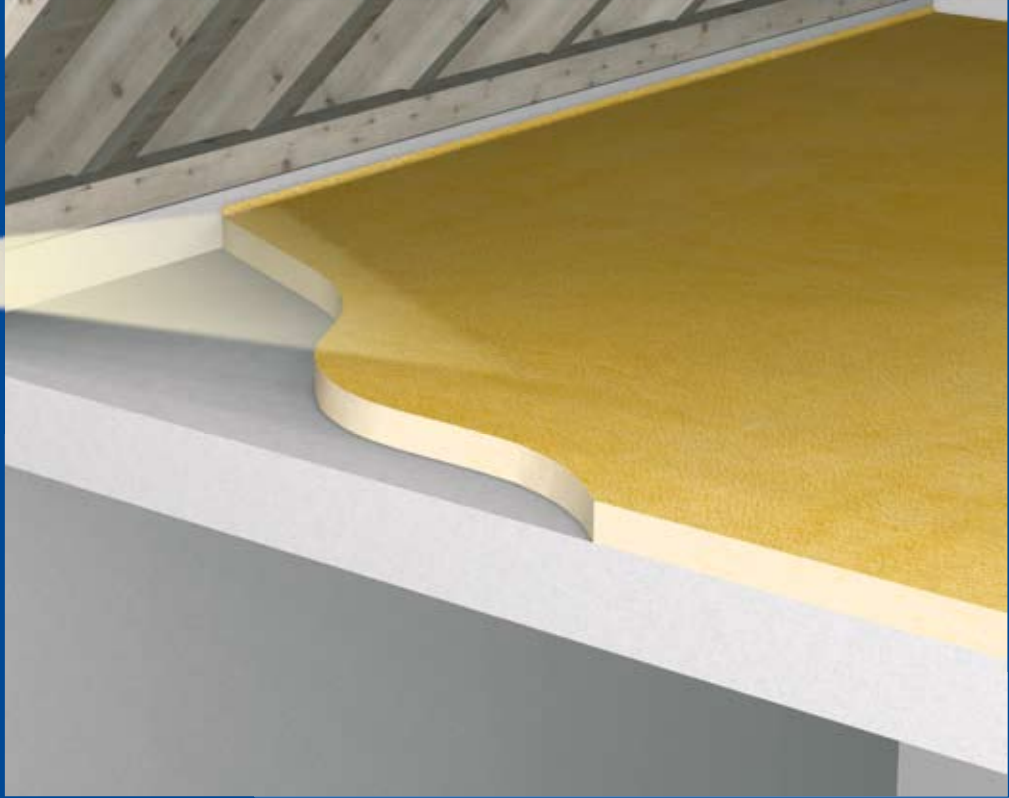

Thermal insulation of the ceiling of a concrete framed building is the most simple and cost effective solution in energy conservation, if the top floors of the building are occupied. This is assuming the roof void remains unheated or not converted into living quarters.

Elastopor H can be applied to the loft floor, directly onto the substrate, provided it is clean and dry. The Elastogran spray foam can be installed in areas difficult to access and the in-situ process seals all penetrations through the floor occurring near chimneys or pipes. If the loft space is exposed to foot traffic, for example for maintenance work or used as storage space, chipboard can be loose laid over the top.

- ▶ no airtight flat area (vapour barrier) necessary
- ▶ cost-effective to install
- ▶ adapts to the substrate without gaps
- ▶ no ventilation of the insulating layer

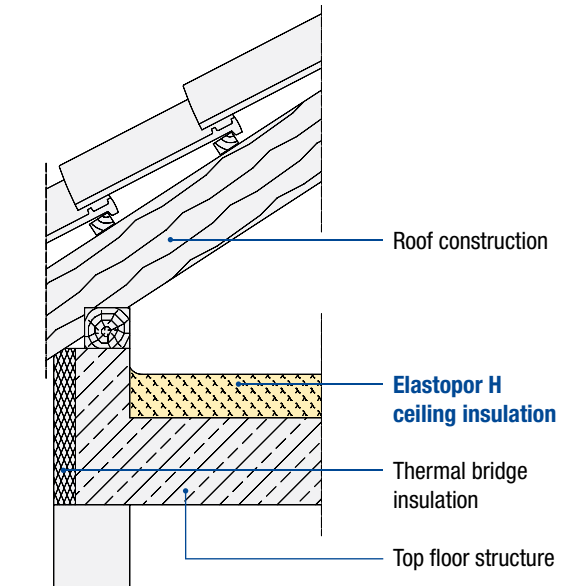

Insulation to the floor of an unheated loft/attic space

Floor structure	Thermal conductance U-value W/(m <sup>2</sup> ·K) with Elastopor H *						
	without insulation	40 mm	60 mm	80 mm	100 mm	120 mm	140 mm
Reinforced concrete ceiling 160 mm, thermal conductivity $\lambda = 2.10 \text{ W/(m}\cdot\text{K)}$	3,62	0,59	0,41	0,32	0,26	0,22	0,19

\* Thermal conductivity Elastopor H,  $\lambda = 0.028 \text{ W/(m}\cdot\text{K)}$

# Floor

## Insulation on top of ground floors with underfloor heating using Elastopor H



Thermal insulation above the floor slab is advisable where underfloor heating is installed. The insulating layer separates the heated and unheated areas inside a building and in this way reduces any loss of valuable heating energy. Even with rooms only used occasionally, insulation on top of floors with underfloor heating has benefits because the “cold” floor heats up more rapidly and no heat is passed into the floor slab.

As with roof void insulation, Elastopor H spray foam is simply sprayed on to a dry, dust-free base. Foam can be applied quickly and easily to pipes, water, heating and electrical installations. After a brief curing time, the screed and heating pipes are laid, the screed layer being separated from the insulation by a sheet.

The high compressive strength PU foam guarantees a secure substrate with excellent insulating performance even when subjected to permanent stress.

- ▶ insulation subjected to permanent stress
- ▶ deformation and compression-free
- ▶ thin insulating layer with high insulating performance
- ▶ comparatively thin floor structure

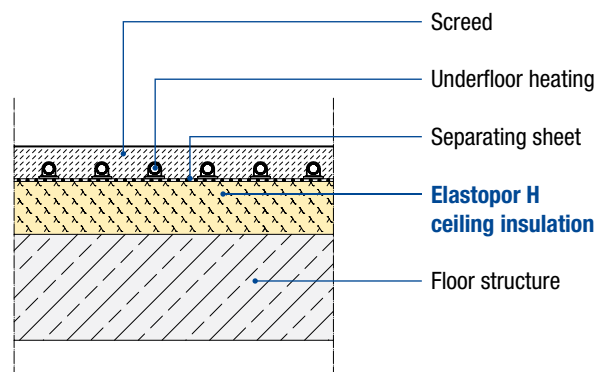

Insulation under the heating screed

Floor structure	Thermal conductance U-value W/(m <sup>2</sup> ·K) with Elastopor H *						
	without insulation	40 mm	60 mm	80 mm	100 mm	120 mm	140 mm
Heating screed 60 mm, concrete ceiling 160 mm, thermal conductivity $\lambda = 2.10$ W/(m·K)							
to the unheated basement	2,18	0,53	0,38	0,30	0,25	0,21	0,18
bordering on to soil	3,46	0,58	0,41	0,32	0,26	0,22	0,19

\* Thermal conductivity Elastopor H,  $\lambda = 0.028$  W/(m·K)

# Basement ceiling

## Insulation of basement ceilings/soffit using Elastopor H

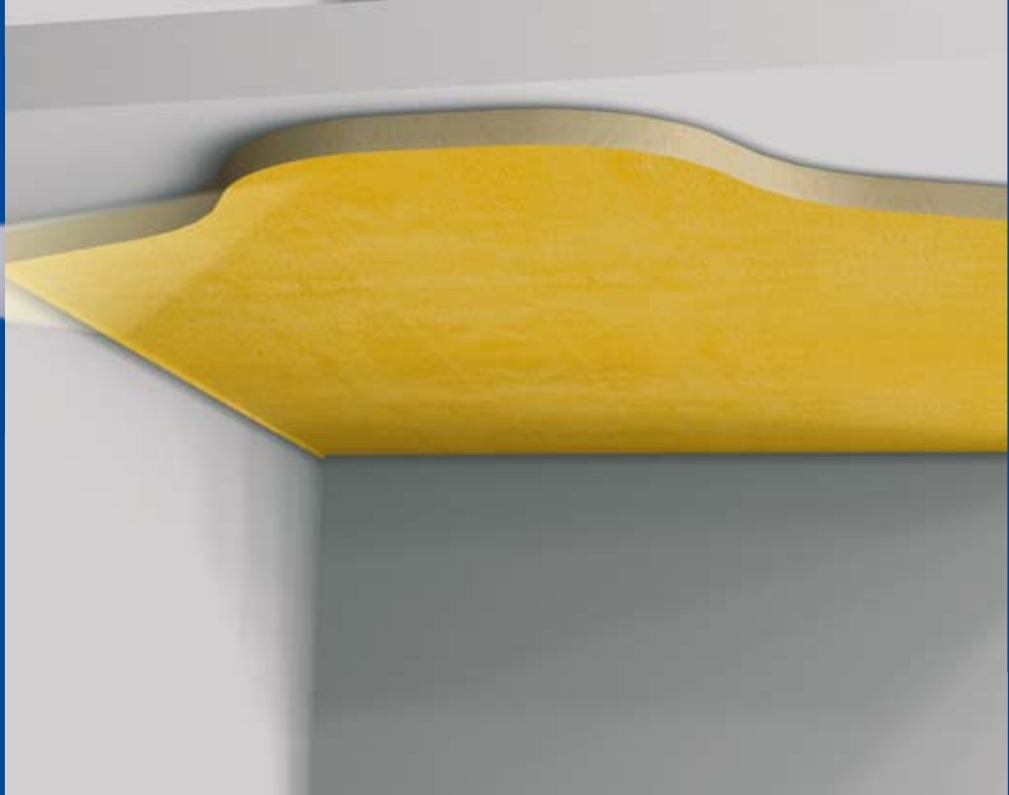

Cold ground floors of a building occur if the soffit is not insulated against the unheated basement. The low temperatures in the concrete soffit can lead to high energy losses, interstitial condensation and even the formation of mould. This problem can easily be resolved by insulating with Elastopor H.

The Elastogran spray foam system can be applied to most soffits, without costly access equipment. The material is self-adhesive and requires no labour intensive cutting and fixing. Water pipes and electrical cables can easily be hung beneath the insulation. Any uneven areas such as old vaulted basements, ribbed or waffle shaped soffits, can be rapidly and economically insulated using Elastopor H. The insulation is seamless compared to conventional insulating methods, so there is no risk of cold air penetrating through the ceiling and creating heat loss.

- ▶ inhibits mould formation
- ▶ suitable for uneven areas and vaulted ceilings
- ▶ no drilling and fixing
- ▶ seamless insulation under pipes or installations

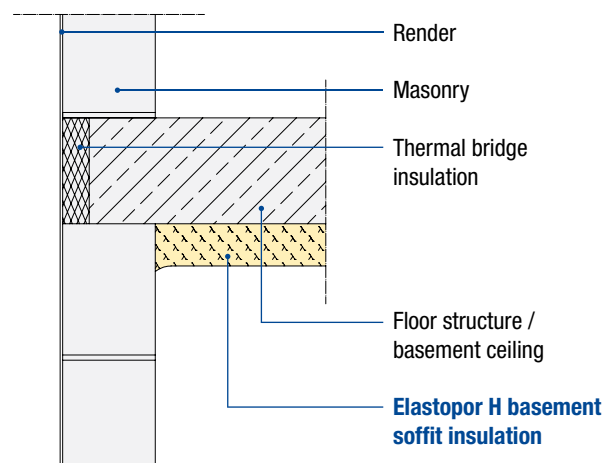

Soffit insulation for unheated basements

Ceiling structure	Thermal conductance U-value $W/(m^2 \cdot K)$ with Elastopor H *							
	without insulation	40 mm	50 mm	60 mm	70 mm	80 mm	90 mm	100 mm
Concrete ceiling 160 mm, thermal conductivity $\lambda = 2.10 W/(m \cdot K)$	2,40	0,54	0,45	0,39	0,34	0,31	0,28	0,25

\* Thermal conductivity Elastopor H,  $\lambda = 0.028 W/(m \cdot K)$



# Roof and wall

## Internal insulation of livestock and agricultural buildings using Elastopor H



Agricultural buildings such as stables, barns and crop stores are exposed to major stresses. Transpiration and excretions from animals, exhaust fumes from agricultural vehicles and high levels of humidity and condensation affect the building construction, along with external weather conditions such as storms, rain, snow, hail and heat.

A potential insulation for agricultural purposes should be durable, resistant and of course cost-effective.

Elastopor H spray foam caters for all possible external geometries and insulates the roof both from inside and from outside. The cured material provides effective protection from draughts and strengthens the building through the compact, jointless insulating layer. Elastopor H has a positive effect on the life and value of the fabric of the building.

- ▶ prevents condensation
- ▶ adapts to any shape without joints
- ▶ reinforces the building construction
- ▶ inert material
- ▶ rapid, economic application
- ▶ saves energy costs

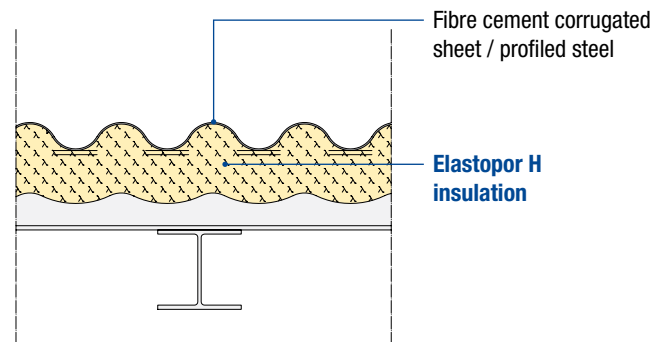

Internal roof and wall insulation of agricultural buildings

Wall construction Roof construction	Thermal conductance U-value W/(m <sup>2</sup> ·K) with Elastopor H *							
	without insulation	40 mm	50 mm	60 mm	70 mm	80 mm	90 mm	100 mm
Roof: fibre cement corrugated sheet	7,14	0,64	0,52	0,44	0,38	0,33	0,30	0,27
Wall: profiled steel	5,88	0,63	0,51	0,43	0,38	0,33	0,30	0,27

\* Thermal conductivity Elastopor H,  $\lambda = 0.028 \text{ W/(m}\cdot\text{K)}$

# Case studies

Elastogran's Elastopor H spray foam system has proved to stand the test of time due to its physical properties and economic installation. The following is a small selection from a large number of buildings successfully insulated using Elastopor H.







## Contact

You can contact the specialists in polyurethane system houses at BASF and Elastogran throughout the world. We are happy to give advice on the installation and application of Elastopor H spray foam.

E-mail us any queries or requests you may have at the following address, stating the country where there is interest in using the Elastopor H spray system.

**E-Mail:**

**[sprayfoam@elastogran.com](mailto:sprayfoam@elastogran.com)**

We will forward your message to the appropriate Elastogran office and guarantee you a quick, straightforward reply.



Elastogran Headquarter

**Elastogran GmbH**  
Elastogranstraße 60  
49448 Lemförde  
Germany

Phone: +49 5443 120  
Fax: +49 5443 12 2201  
E-Mail: [sprayfoam@elastogran.com](mailto:sprayfoam@elastogran.com)

[www.elastogran.com](http://www.elastogran.com)

European Development Center Sprayfoam

**Elastogran S.A.**  
Polígono Industrial Can Jardí  
Calle Vivaldi, 1-7  
08191 Rubí (Barcelona)  
Spain

Phone: +34 93 680 6100  
Fax: +34 93 680 6200  
E-Mail: [sprayfoam@elastogran.com](mailto:sprayfoam@elastogran.com)

[www.elastogran.com](http://www.elastogran.com)